

Article number: 201134105

Description: E+G Guide bush DIN 172-B24-20-A
with collar

Measures

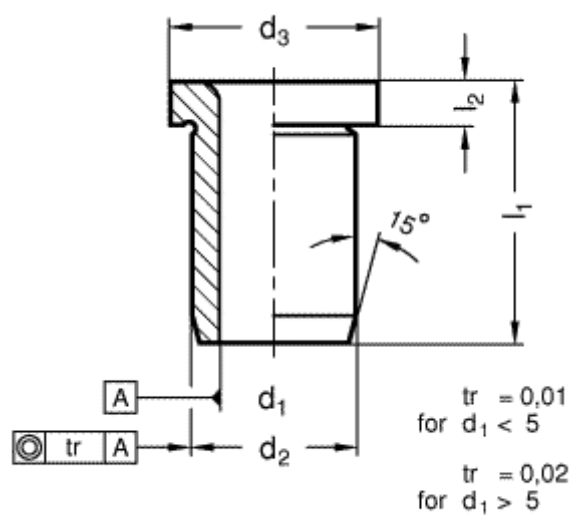

d1 = 25

d2 = 35

d3 = 39

l1 = 20

l2 = 5